

Locking Assemblies

RINGFEDER® RfN 7014

Assembly, Disassembly, Re-Assembly

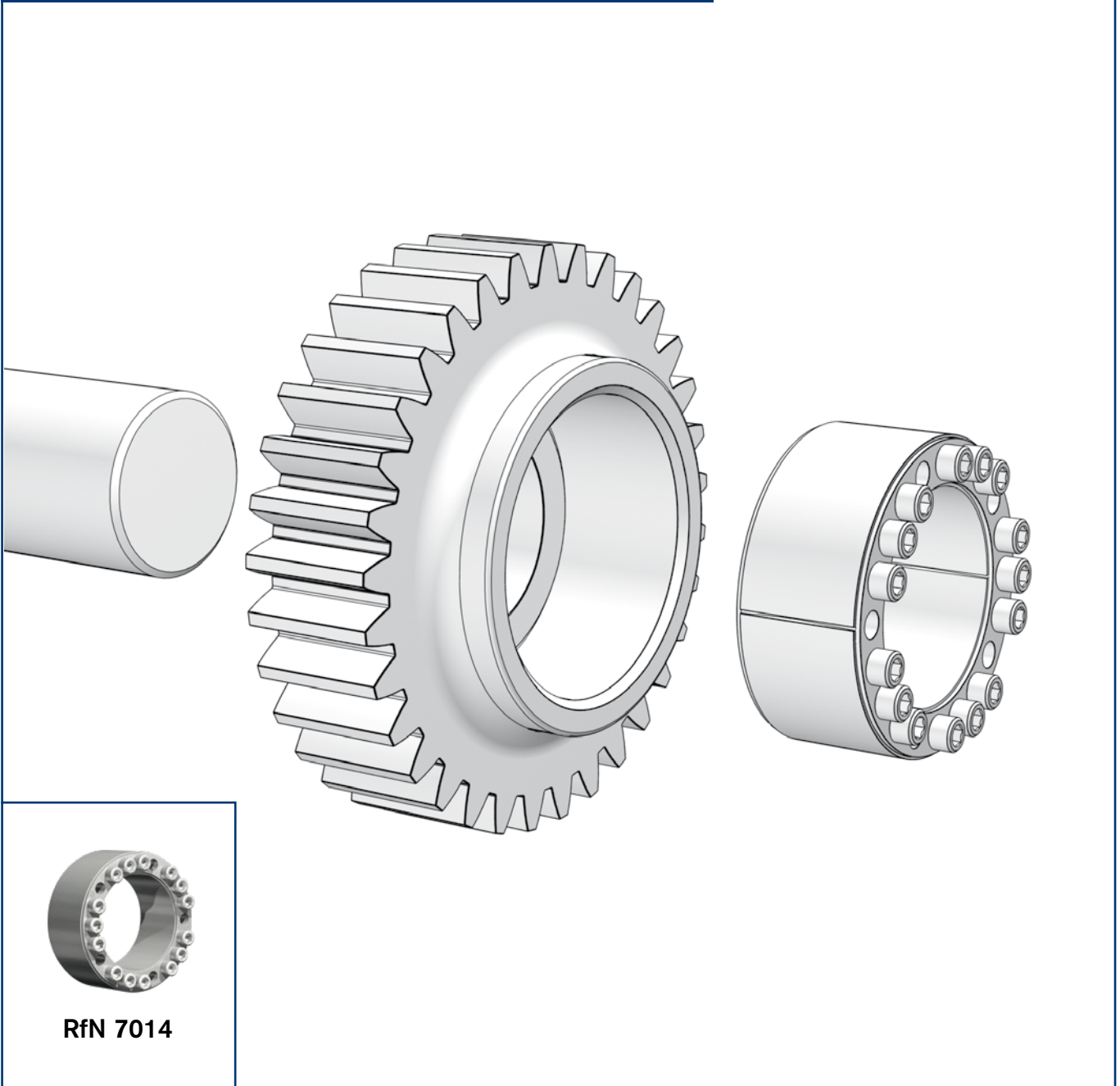

Safety instructions

Rotating machine parts may injure operators and service staff!
Therefore:

- Switch off the drive before assembly work.
- Safeguard the machine against accidental switch-on.
- Mount all covers and protection devices before switching on the machine.
- RINGFEDER® products may only be mounted by specialist staff and for suitable applications.

Attention

- Please read these instructions through carefully.
- In the event of infringement of these notes all claims of liability will become void.
- RINGFEDER POWER TRANSMISSION reserves the right to technical changes to improve the product.
- RINGFEDER® Locking Assemblies are accepted state of the art.

If you experience problems or have any questions, our technical and service staff will be happy to assist you. See the reverse of these instructions for the corresponding contact information.

Used Lubricants

Designation
Shell Omala 220 Gear & Bearing Oil or comparable lubricant

Legend



Assembly



Disassembly



Re-Assembly



Cleaning



Oil hub and shaft lightly, if necessary (*do not use oil containing MoS2*).

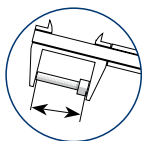

Check screw for deformation and replace, if necessary.



Repeat the described procedure cross-wise the specified number of times.



Repeat the described procedure as many times as specified.



Check for permissible peak-to-valley height.



Attention! Absolutely observe!



Valid data on the required tightening torque can be found in the Product Paper & Tech Paper "Locking Assemblies" or on our website. Please check whether the machinery manufacturer has provided discrepant tightening torque values.

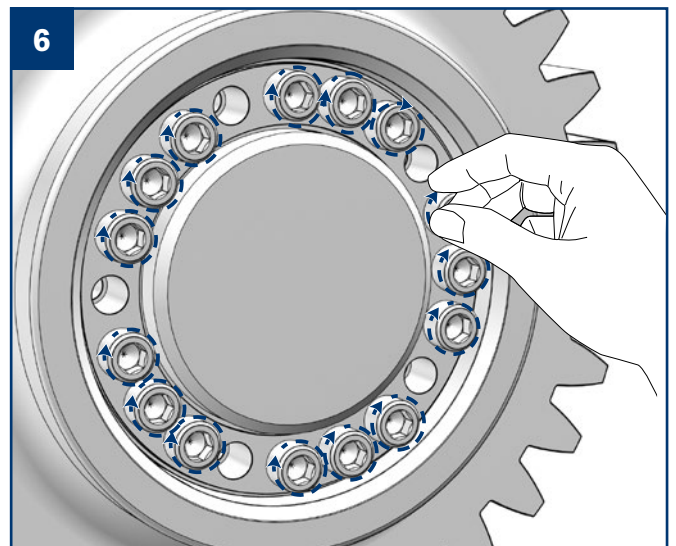
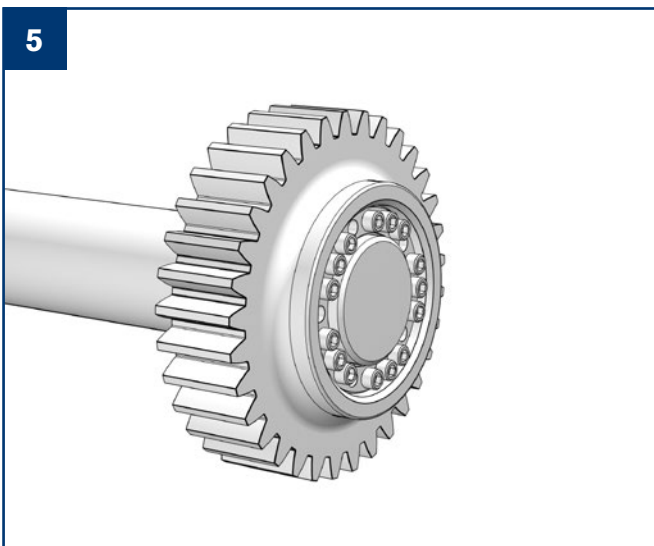
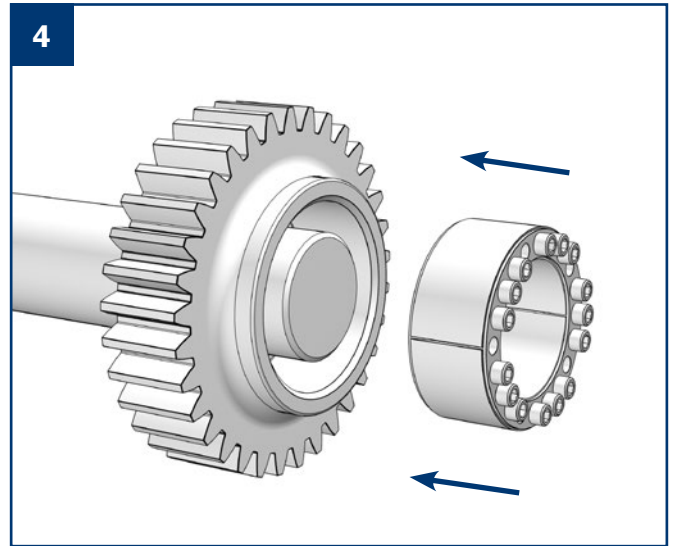
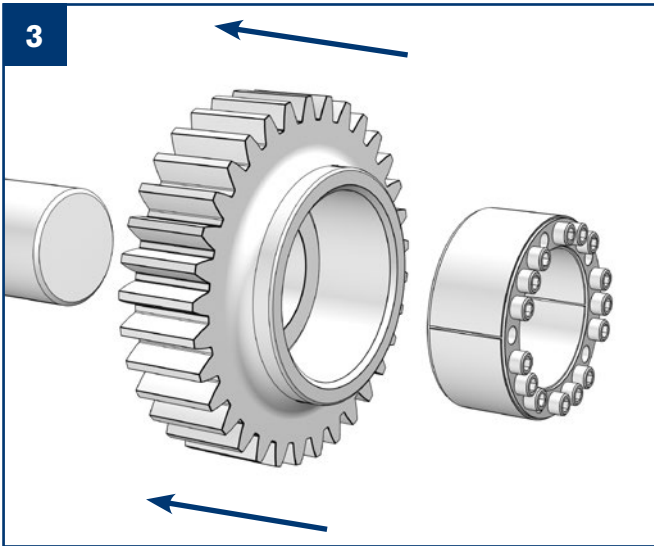
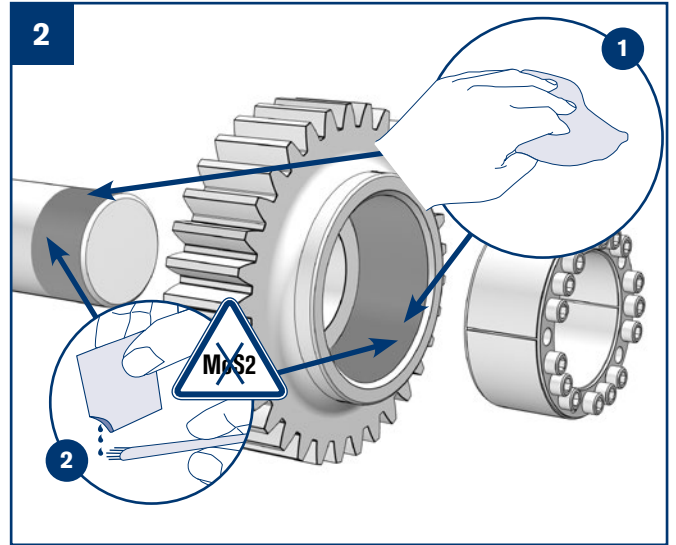
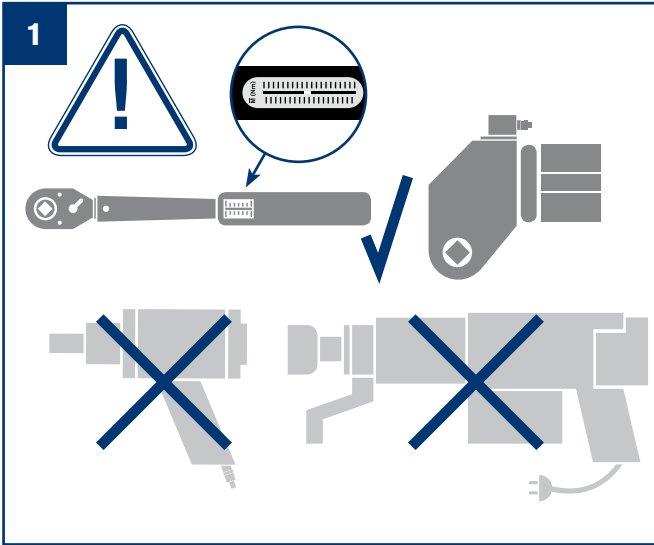

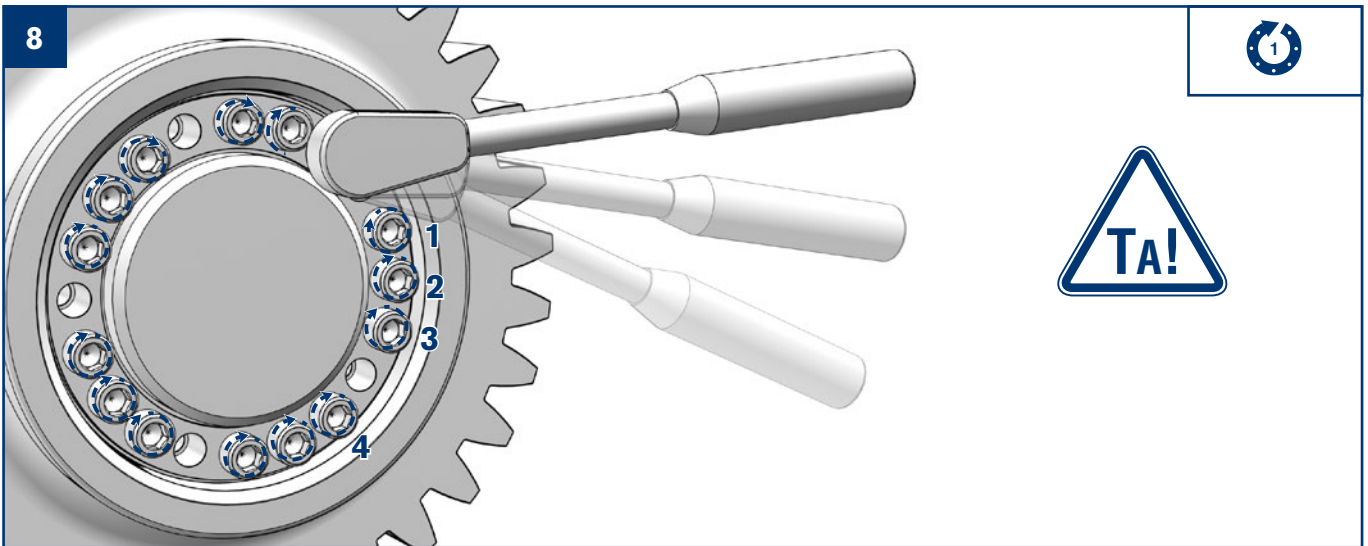
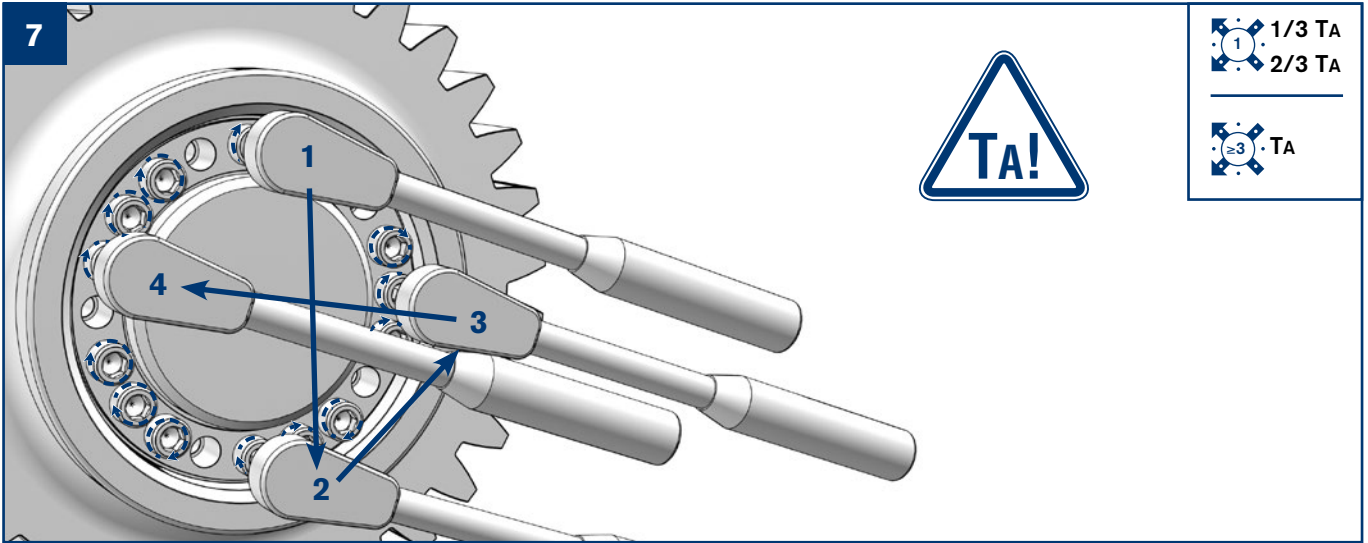

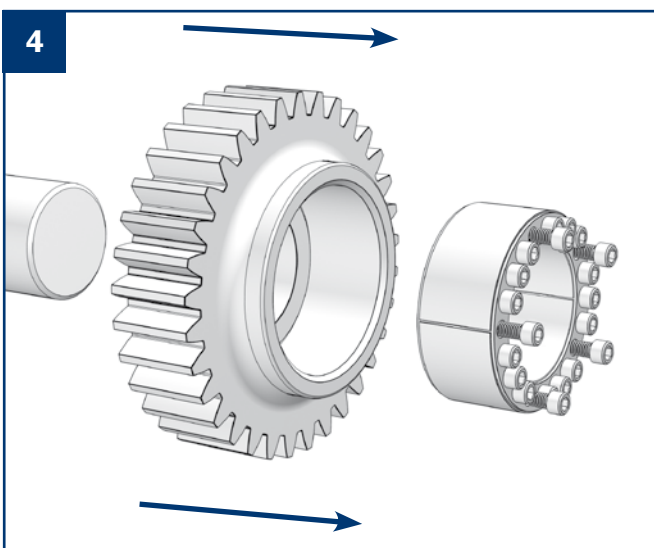
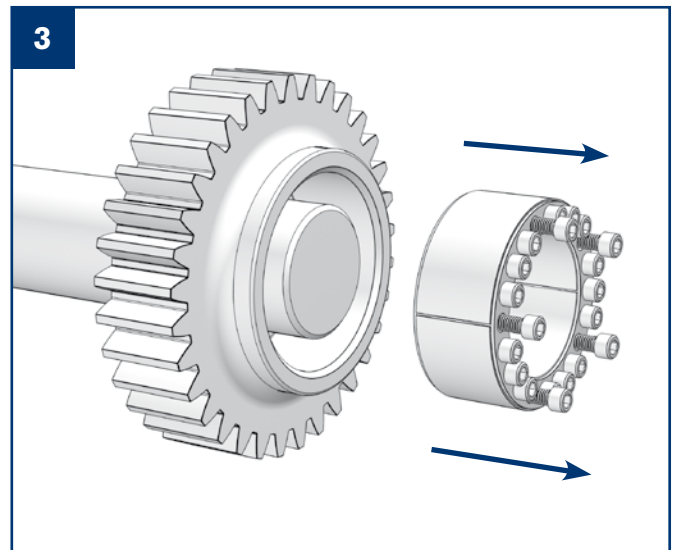
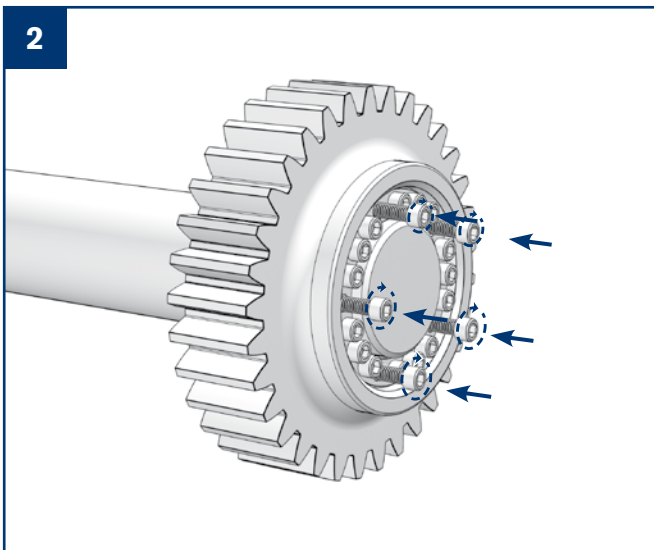
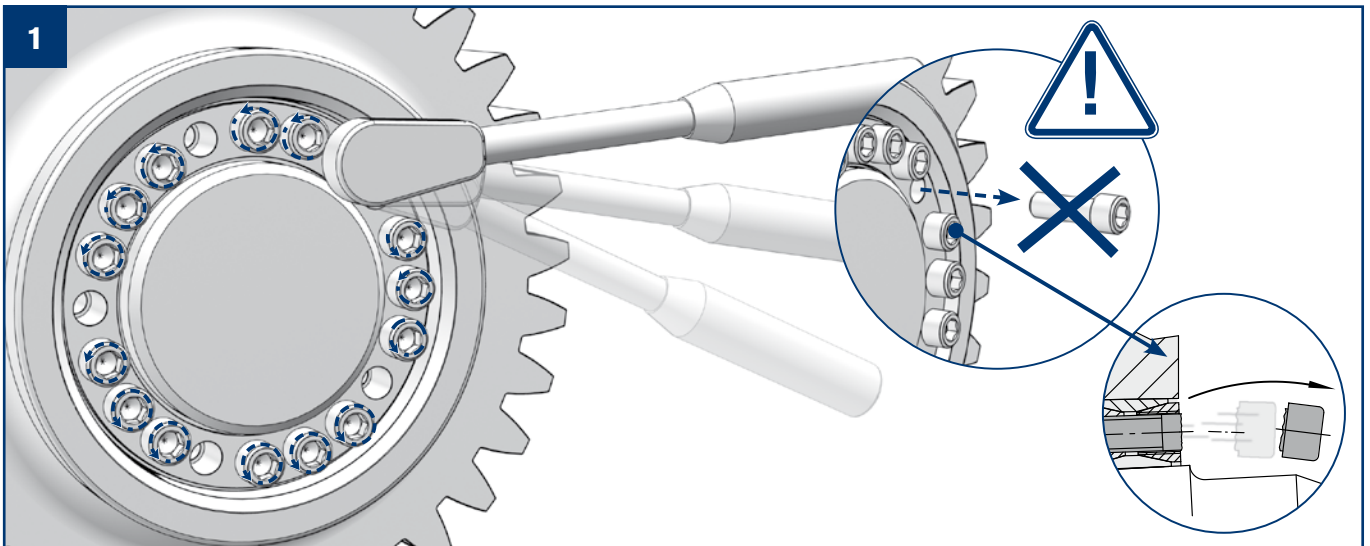

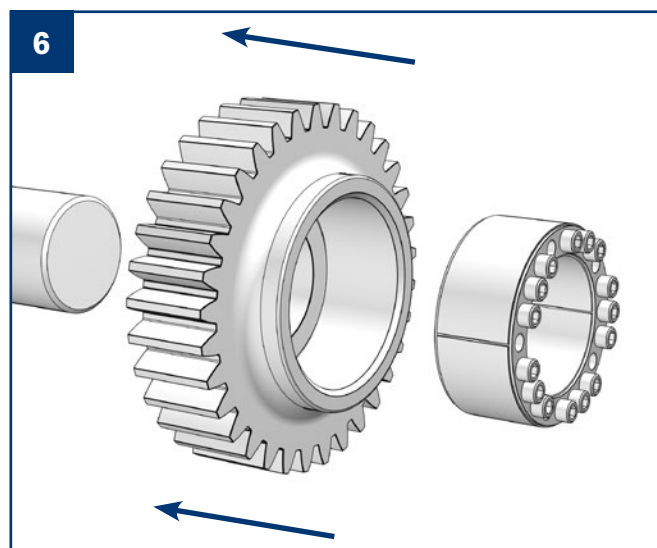
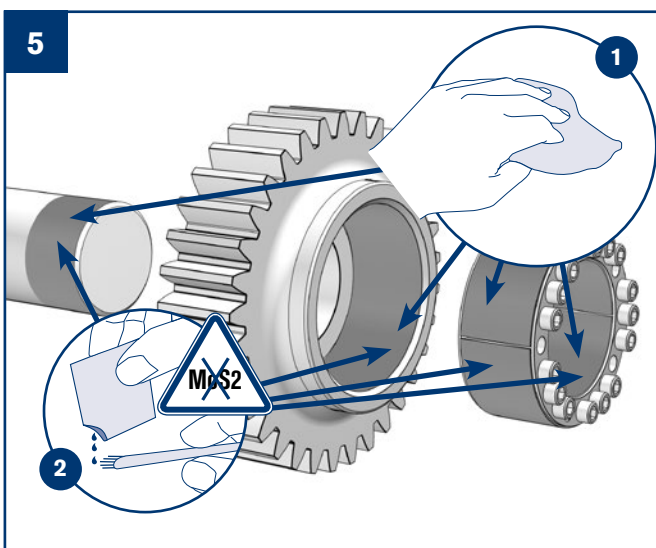
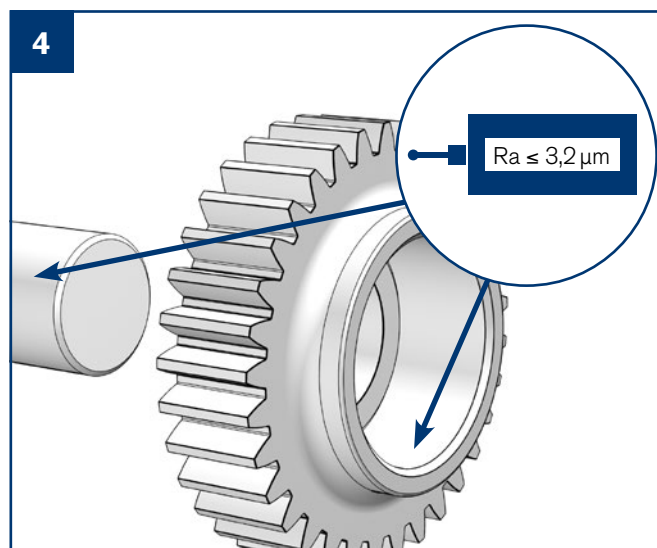
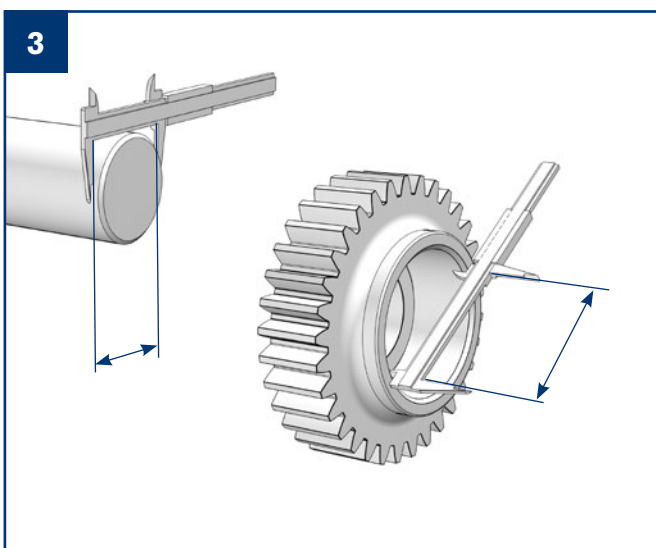
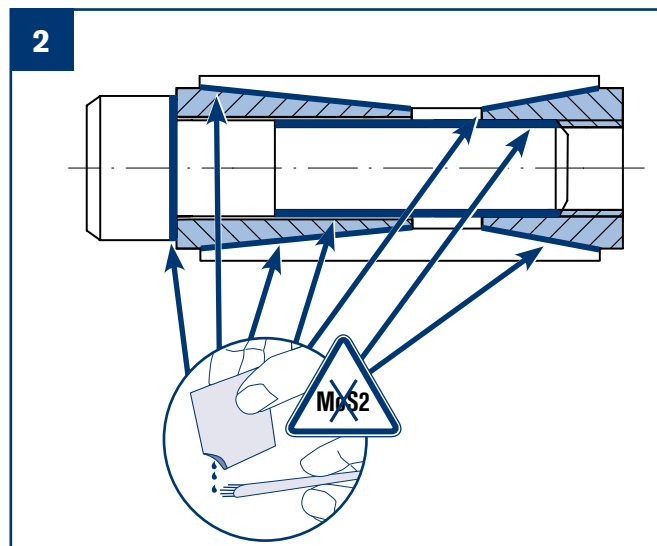
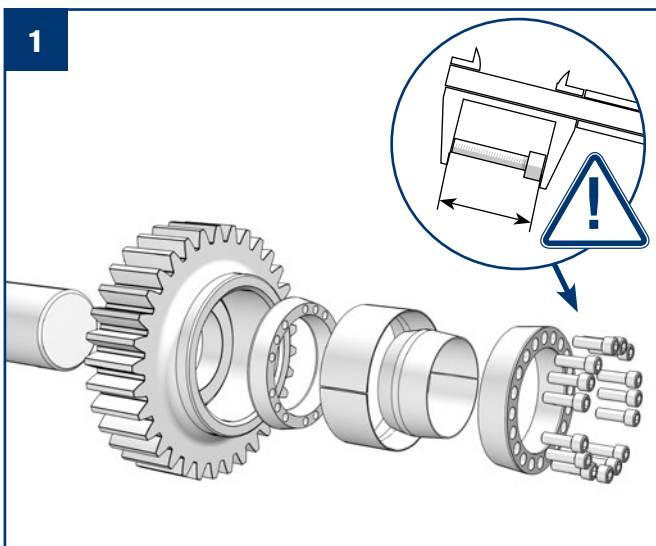

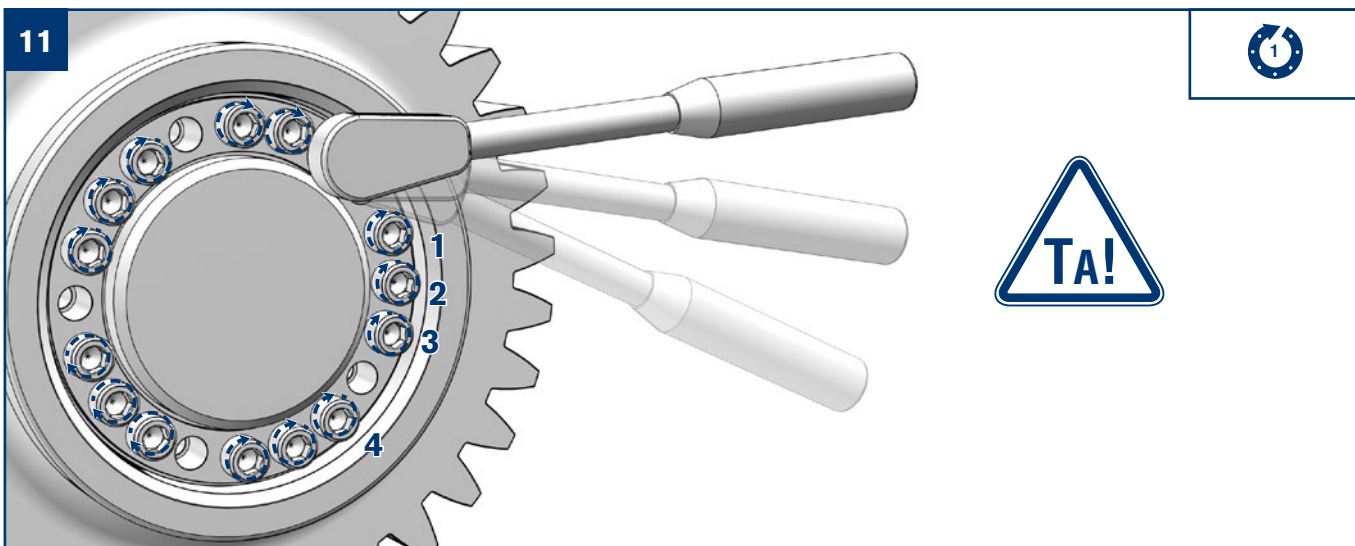
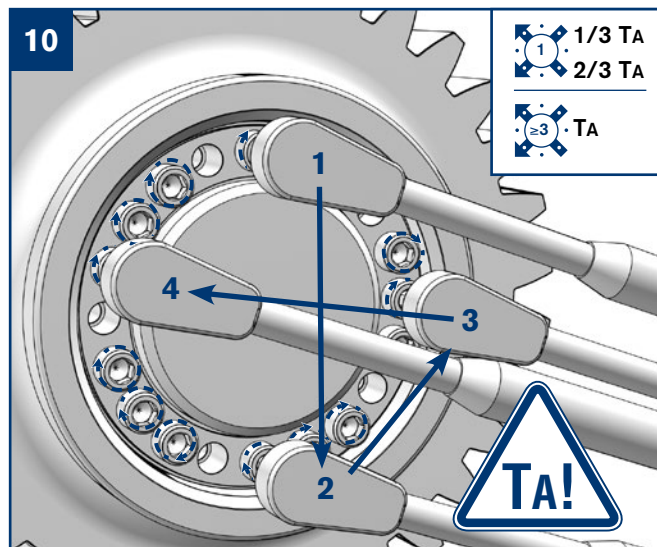
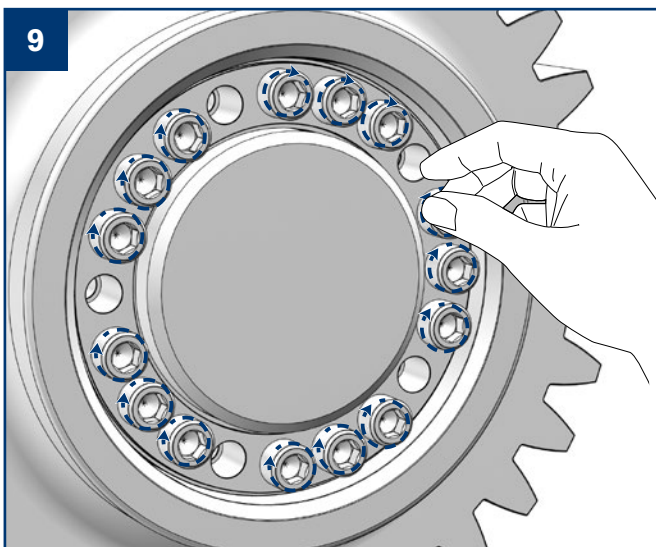
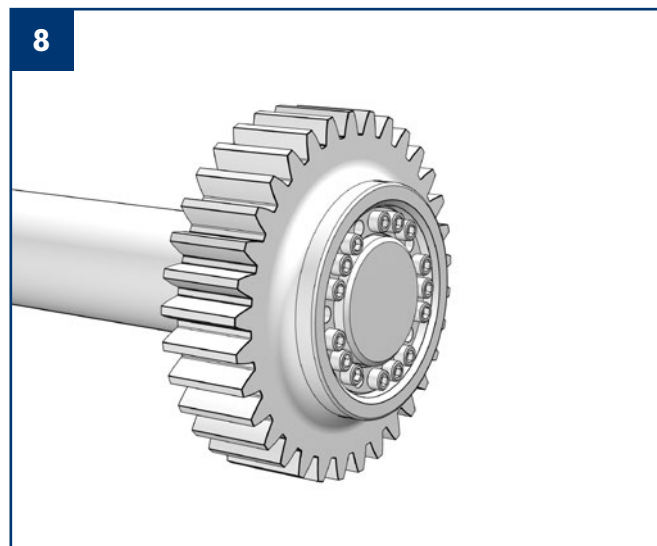
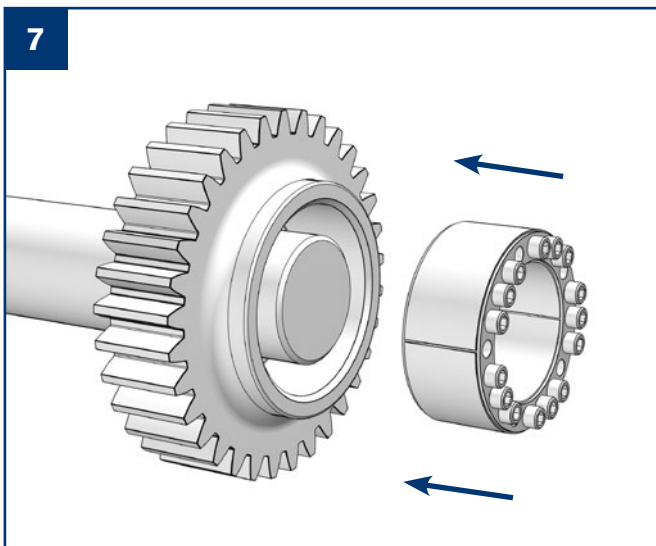

RINGFEDER POWER TRANSMISSION GMBH

Werner-Heisenberg-Straße 18, D-64823 Groß-Umstadt, Germany · Phone: +49 (0) 6078 9385-0 · Fax: +49 (0) 6078 9385-100
E-mail: sales.international@ringfeder.com

RINGFEDER POWER TRANSMISSION TSCHAN GMBH

Zweibrücker Straße 104, D-66538 Neunkirchen, Germany · Phone: +49 (0) 6821 866-0 · Fax: +49 (0) 6821 866-4111
E-mail: sales.tschan@ringfeder.com

RINGFEDER POWER TRANSMISSION USA CORPORATION

165 Carver Avenue, Westwood, NJ 07675, USA · Toll Free: +1 888 746-4333 · Phone: +1 201 666 3320 · Fax: +1 201 664 6053
E-mail: sales.usa@ringfeder.com

HENFEL INDÚSTRIA METALÚRGICA LTDA.

Av. Major Hilário Tavares Pinheiro, 3447 · CEP 14871 300 · Jaboticabal - SP - Brazil · Phone: +55 (16) 3209-3422
E-mail: vendas@henfel.com.br

RINGFEDER POWER TRANSMISSION INDIA PRIVATE LIMITED

Plot No. 4, Door No. 220, Mount - Poonamallee Road, Kattupakkam, Chennai – 600 056, India
Phone: +91 (0) 44-2679 1411 · Fax: +91 (0) 44-2679 1422 · E-mail: sales.india@ringfeder.com

KUNSHAN RINGFEDER POWER TRANSMISSION COMPANY LIMITED

NO. 406 Jiande Road, Zhangpu 215321, Kunshan, Jiangsu Province, China
Phone: +86 (0) 512-5745-3960 · Fax: +86 (0) 512-5745-3961 · E-mail: sales.china@ringfeder.com

Partner for Performance
www.ringfeder.com

